

2.5

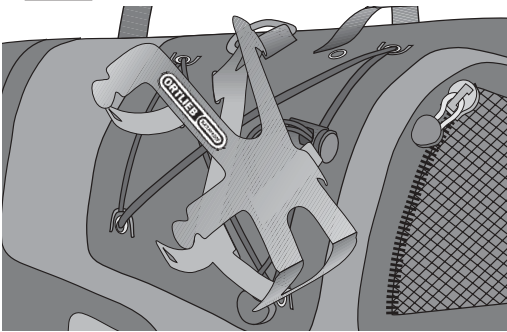

2.6

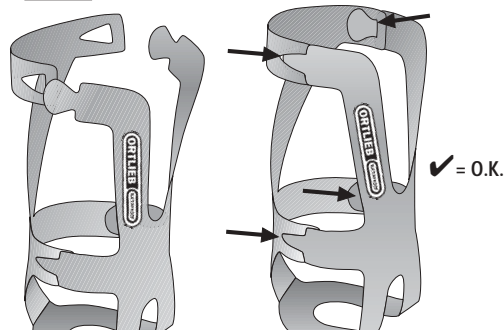

# LIEGERADTASCHEN RECUMBENT PANNIERS



- DE** MONTAGEANWEISUNG:
- GB** ASSEMBLY INSTRUCTIONS:
- FR** INSTRUCTIONS DE MONTAGE:
- IT** ISTRUZIONI DI MONTAGGIO:
- NL** MONTAGE HANDLEIDING:
- DK** MONTERINGSVEJLEDNING:
- ES** INSTRUCCIONES DE MONTAJE:
- SE** MONTERINGSANVISNING:
- NO** MONTERINGSANVISNING:
- FI** ASENNUSOHJEET:
- PL** INSTRUKCJA MONTAZU:
- JP** 換気の良い所に保管してください。

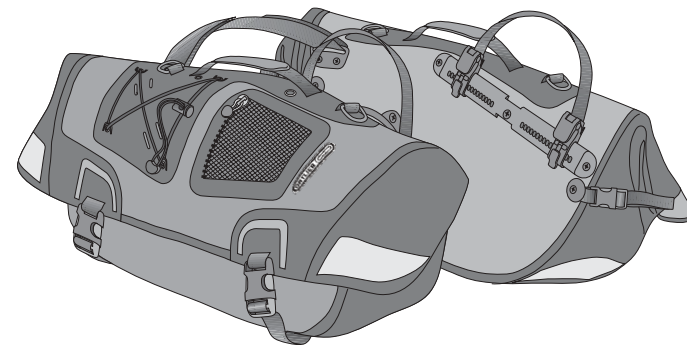

- INHALT:**
- CONTENTS:**
- CONTENU:**
- CONTENUTO:**
- INHOUDE:**
- INDHOLD:**
- CONTENIDO:**
- INNEHÅLL:**
- INNHOUD:**
- SISÄLLYS:**
- ZAWARTOSC:**
- 火気厳禁**

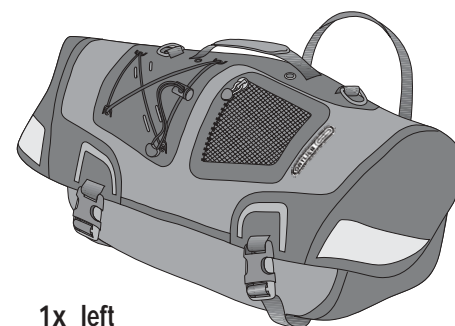

1x left

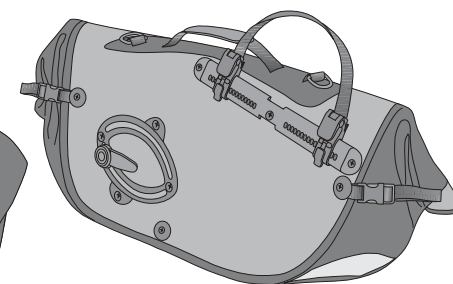

1x right



1x **C**

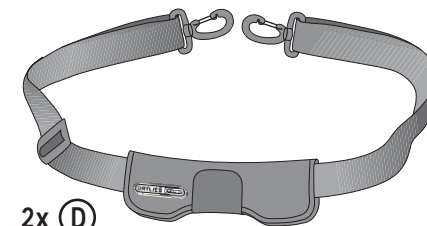

2x **D**

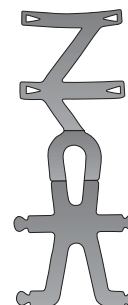

1x **E**

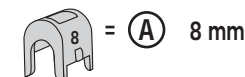

= **A** 8 mm

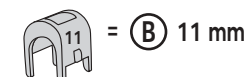

= **B** 11 mm

## ACCESSOIRES

= + Art. # FL 151/FL 152

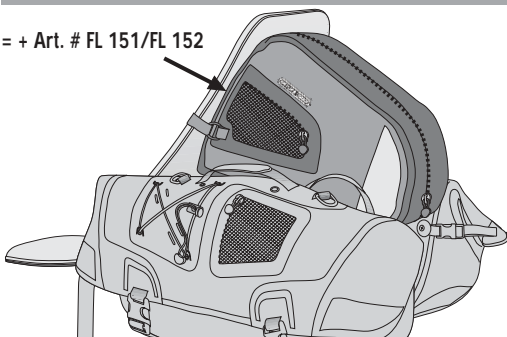

= + Art. # F 14

